

14

Cam rollers

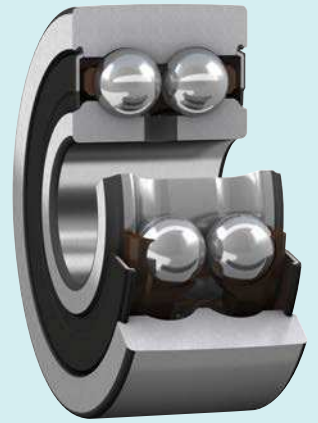

14 Cam rollers

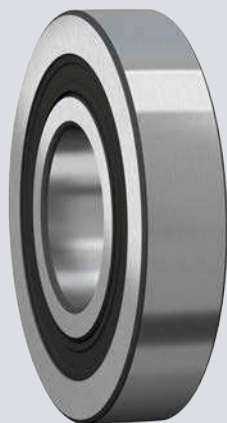

Designs and variants	933
Single row cam rollers	933
Double row cam rollers	933
Cages	934
Bearing data	934
(Dimension standards, profile of the outer ring running surface, tolerances, internal clearance, defect frequencies)	
Loads	935
(Dynamic loads, static loads, axial loads, minimum load, equivalent dynamic bearing load, equivalent static bearing load)	
Temperature limits	936
Speed limits	936
Design considerations	936
Pins	936
Support surfaces	936
Guide flanges	936
Designation system	937
Product tables	
14.1 Single row cam rollers	938
14.2 Double row cam rollers	940

More information

General bearing knowledge 17

Bearing selection process 59

Lubrication 109

Bearing interfaces 139

Sealing, mounting and dismounting 193

SKF cam rollers (yoke-type track rollers based on ball bearings) are designed to run on all types of tracks and to be used in cam drives, conveyor systems, etc.

The outer ring running surface is crowned as standard. Double row cam rollers are also available with a cylindrical (flat) outer ring running surface.

SKF supplies cam rollers greased, sealed and ready-to-mount. They are available in two main designs and also as variants of these:

- single row cam rollers based on deep groove ball bearings in the 62 series ([fig. 1](#))
- double row cam rollers based on double row angular contact ball bearings in the 32 dimension series ([fig. 2](#))

Cam roller features

- **Accommodate high radial loads**
The thick-walled outer ring enables high radial loads, while reducing distortion and bending stresses.
- **Accommodate tilting moments**
Double row cam rollers accommodate higher tilting moments than single row cam rollers.
- **Long service life**
The crowned outer ring running surface is beneficial for applications where outer ring tilting relative to the track may occur or where edge stresses need to be minimized.
- **Relatively high speed capability**

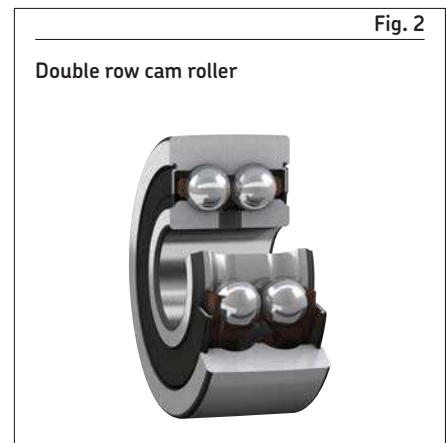
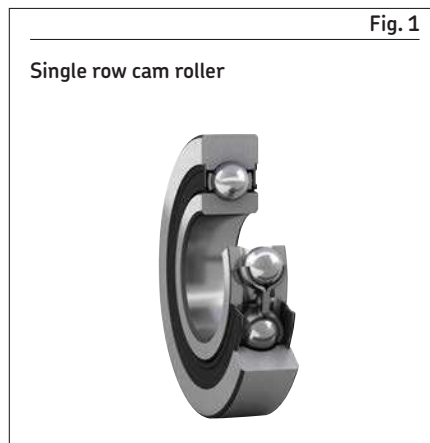

Designs and variants

Single row cam rollers

- are based on deep groove ball bearings in the 62 series (fig. 1)
- have a thick-walled outer ring with its running surface crowned
- are capped with a sheet steel reinforced NBR contact seal on both sides
- are greased for the life of the bearing and cannot be relubricated (table 1)

When capped bearings must operate under certain conditions, such as very high speeds or high temperatures, some grease may leak. For bearing arrangements where this would be detrimental, appropriate actions should be taken.

Double row cam rollers

- are based on double row angular contact ball bearings in the 32 dimension series (fig. 2)
- have a thick-walled outer ring with its running surface available in two designs:
 - crowned as standard (series designation 3058.. C)
 - cylindrical (flat) (series designation 3057.. C)
- have a 30° contact angle, enabling, together with the two ball sets, tilting moments to be accommodated
- are supplied capped in two variants:
 - with a sheet steel shield on both sides that extends into a recess on the inner ring (designation suffix -2Z)
 - with an NBR contact seal on both sides (designation suffix -2RS1)

These cam rollers are not listed in this catalogue, but can be found online at skf.com/go/17000-14-2.
- are greased for the life of the bearing under normal operating conditions (table 1)

- should be relubricated, if:
 - subjected to moisture or solid contaminants
 - they run for long periods at temperatures above 70 °C (160 °F)
- have a lubrication hole in the inner ring
 - Where suitable ducts are provided in the pin, the bearings are easy to relubricate.
 - The grease should be applied slowly to avoid damaging the shields or seals.

When capped bearings must operate under certain conditions, such as very high speeds or high temperatures, grease may appear between the inner ring and capping device. For bearing arrangements where this would be detrimental, appropriate actions should be taken.

Table 1

Technical specifications of SKF greases for track rollers

Bearing type	Specifications for the initial grease fill							Thickener	Base oil type	NLGI grade	Base oil viscosity [mm ² /s]		Grease for relubrication
	Temperature range ¹⁾										at 40 °C (105 °F)	at 100 °C (210 °F)	
	-50	0	50	100	150	200	250	°C					
Single row cam roller (D ≤ 62 mm)								Lithium soap	Mineral	2	70	7,3	–
Single row cam roller (D > 62 mm), Double row cam roller								Lithium soap	Mineral	3	100	10	LGMT 3 ²⁾
Support roller, Cam follower								Lithium complex soap	Mineral	2	160	15,5	LGWA 2
	-60	30	120	210	300	390	480	°F					

¹⁾ Refer to the SKF traffic light concept (page 117).
²⁾ Single row cam rollers cannot be relubricated.



Cages

SKF cam rollers are fitted with one of the cages shown in [table 2](#). Double row cam rollers are equipped with two cages.

When used at high temperatures, some lubricants can have a detrimental effect on polyamide cages. For additional information about the suitability of cages, refer to *Cages*, [page 187](#).

Table 2

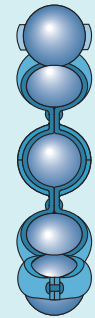
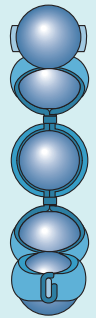
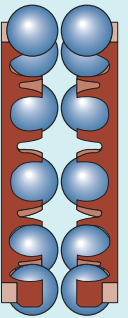
Cages for cam rollers			
	Single row cam rollers		Double row cam rollers
			
Cage type	Riveted, ball centred	Ribbon-type, ball centred	Snap-type, ball centred
Material	Stamped steel	Stamped steel	PA66, glass fibre reinforced
Suffix	-	-	-

Bearing data

	Single row cam rollers	Double row cam rollers
Dimension standards	ISO 15, dimension series 02, except for the outside diameter	ISO 15, dimension series 32, except for the outside diameter
Profile of the outer ring running surface	Radius = 400 mm	<ul style="list-style-type: none"> • 3058.. C design Radius = 400 mm • 3057.. C design Cylindrical (flat)
Tolerances For additional information → page 35	Normal, except: <ul style="list-style-type: none"> • diameter of the crowned running surface: twice the Normal tolerance Values for Normal tolerance class: ISO 492 (table 2, page 38)	
Internal clearance For additional information → page 182	C3 Values: ISO 5753-1 (table 6, page 252)	Normal Values 32 A series: (table 8, page 396)
Defect frequencies	→ skf.com/bearingcalculator	



Loads

<p>Dynamic loads</p>	<p>As track rollers are not supported in a housing, the outer rings deform, leading to an altered load distribution and bending stresses in the outer ring.</p> <p>The basic load ratings listed in the product tables, page 938, take into account the altered load distribution, while the maximum radial loads $F_{r\max}$ (product tables) are based on the bending stresses.</p>	<p>Symbols</p> <p>C_0 basic static load rating [kN] (product tables, page 938)</p> <p>F_r radial load [kN]</p> <p>$F_{r\max}$ maximum permissible dynamic radial load [kN] (product tables)</p> <p>$F_{0r\max}$ maximum permissible static radial load [kN] (product tables)</p> <p>F_{rm} minimum radial load [kN]</p> <p>P equivalent dynamic bearing load [kN]</p> <p>P_0 equivalent static bearing load [kN]</p>
<p>Static loads</p>	<p>Permissible static load is the lower value of $F_{0r\max}$ or C_0 (product tables).</p>	
<p>Axial loads</p>	<p>Cam rollers are intended for predominantly radial loads. However, axial loads can occur because of skew or tilting or when the outer ring runs against flanges for brief periods.</p> <p>Axial loads acting continuously on the outer ring may reduce the cam roller service life. To evaluate these influences, contact the SKF application engineering service.</p>	
<p>Minimum load</p> <p>For additional information → page 106</p>	<p>$F_{rm} = 0,0167 C_0$</p>	
<p>Equivalent dynamic bearing load</p> <p>For additional information → page 91</p>	<p>$P = F_r$</p>	
<p>Equivalent static bearing load</p> <p>For additional information → page 105</p>	<p>$P_0 = F_r$</p>	



Temperature limits

The permissible operating temperature for cam rollers can be limited by:

- the dimensional stability of the bearing rings and balls
- the cage
- the seals
- the lubricant

Where temperatures outside the permissible range are expected, contact SKF.

Bearing rings and balls

SKF cam rollers are heat stabilized up to at least:

- 120 °C (250 °F) for single row cam rollers
- 150 °C (300 °F) for double row cam rollers

Cages

Steel cages can be used at the same operating temperatures as the bearing rings and balls. For temperature limits of PA66 cages, refer to *Polymer cages*, [page 188](#).

Seals

The permissible operating temperature for NBR seals is -40 to +100 °C (-40 to +210 °F). Temperatures up to 120 °C (250 °F) can be tolerated for brief periods.

Typically, temperature peaks are at the seal lip.

Lubricants

Temperature limits for greases used in SKF cam rollers are provided in [table 1](#), [page 933](#). For temperature limits of other SKF greases, refer to *Selecting a suitable SKF grease*, [page 116](#).

When using lubricants not supplied by SKF, temperature limits should be evaluated according to the SKF traffic light concept ([page 117](#)).

Speed limits

The limiting speed listed in the [product tables](#) is a mechanical limit that should not be exceeded unless the bearing design and the application are adapted for higher speeds.

For additional information, refer to *Operating temperature and speed*, [page 130](#).

Design considerations

Pins

Pins or shafts should be machined to tolerance class g6Ⓜ:

- for normal operating conditions, such as stationary inner ring load
- where easy displacement of the inner ring is required

Support surfaces

Continuously axial loaded cam rollers should be supported over the entire inner ring side face ([fig. 3](#)) and the support surface should be dimensioned according to diameter d_1 ([product tables](#), [page 938](#)).

Guide flanges

For rails or cams with guide flanges, the recommended flange height h_a ([fig. 3](#)) should be:

$$h_a \leq 0,5 (D - D_1)$$

The values for the outer ring diameters D and D_1 are listed in the product tables.

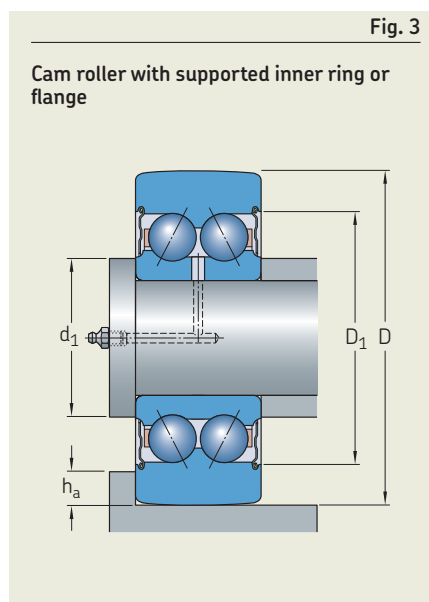

Designation system

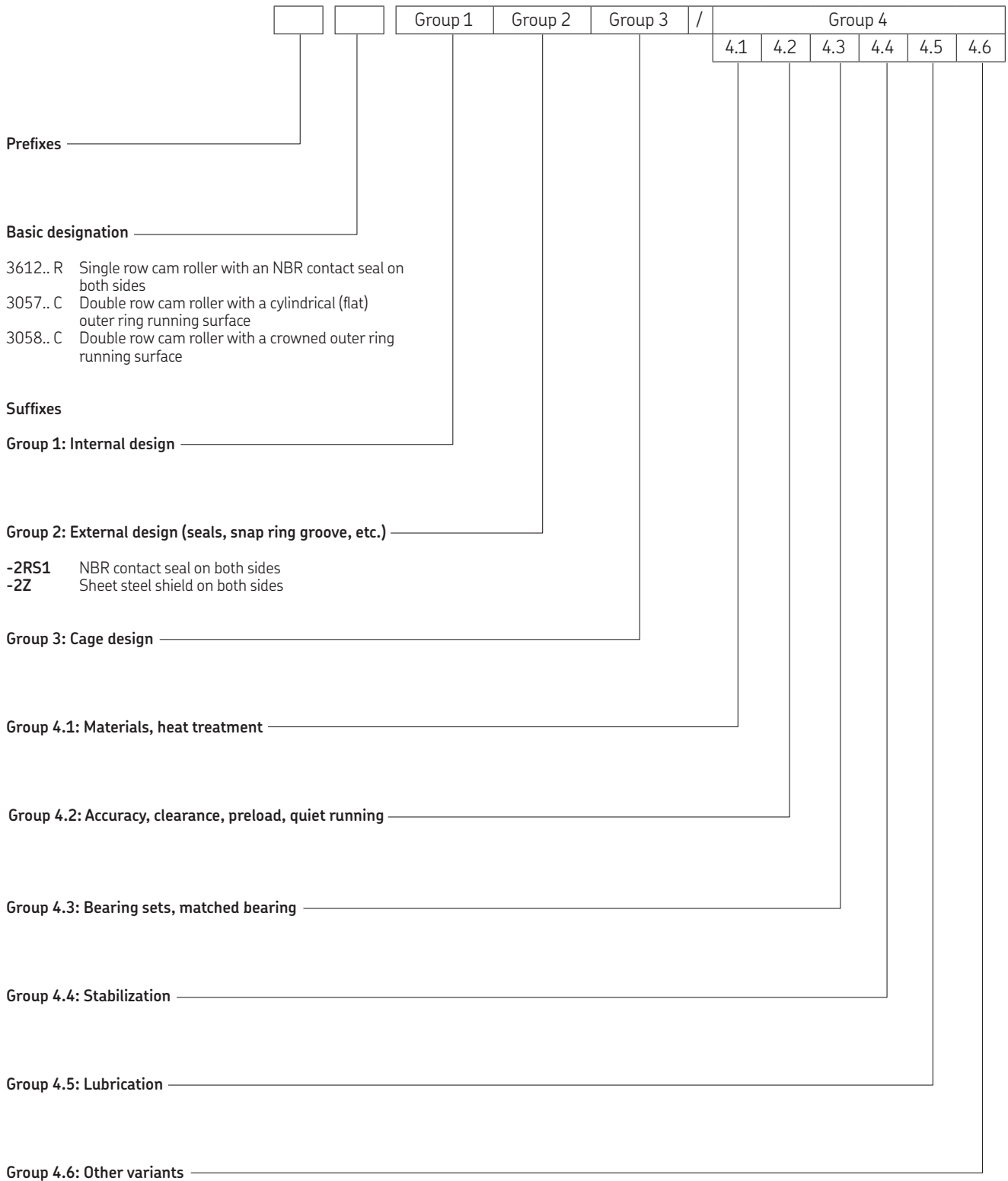

14.1 Single row cam rollers

D 32 – 80 mm

14.1

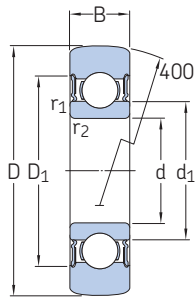

Principal dimensions			Basic load ratings		Fatigue load limit	Maximum radial loads		Limiting speed	Mass	Designation
D	d	B	C	C ₀	P _u	F _r max.	F _{0r} max.			
mm			kN		kN	kN		r/min	kg	–
32	10	9	4,68	2,04	0,085	3,45	5	12 000	0,04	▶ 361200 R
35	12	10	6,24	2,6	0,11	3,35	4,75	11 000	0,051	▶ 361201 R
40	15	11	7,02	3,2	0,137	5,1	7,35	9 500	0,072	▶ 361202 R
47	17	12	8,84	4,25	0,18	8,15	11,6	8 500	0,11	▶ 361203 R
52	20	14	11,4	5,5	0,232	7,5	10,6	7 000	0,15	▶ 361204 R
62	25	15	13	6,8	0,29	12,9	18,6	6 300	0,24	▶ 361205 R
72	30	16	17,4	9,5	0,4	14,6	20,8	5 300	0,34	▶ 361206 R
80	35	17	22,1	11,8	0,5	12,9	18,3	4 500	0,42	▶ 361207 R



Dimensions				Calculation factor
d	d_1 ≈	D_1 ≈	$r_{1,2}$ min.	f_0
mm				–
32	17	24,8	0,6	13
35	18,4	27,4	0,6	12
40	21,7	30,4	0,6	13
47	24,5	35	0,6	13
52	28,8	40,6	1	13
62	34,3	46,3	1	14
72	40,3	54,1	1	14
80	46,9	62,7	1,1	14

14.2 Double row cam rollers

D 32 – 80 mm

14.2

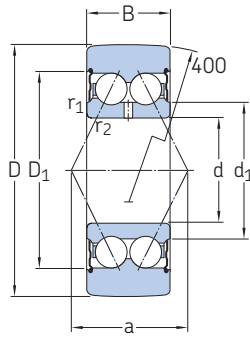

3058.. C-2Z

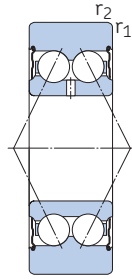

3057.. C-2Z

Principal dimensions			Basic load ratings		Fatigue load limit	Maximum radial loads		Limiting speed	Mass	Designations	
D	d	B	dynamic C	static C ₀		dynamic F _r max.	static F _{0r} max.			Cam roller with crowned running surface	cylindrical running surface
mm			kN		kN	kN		r/min	kg	–	
32	10	14	6,76	3,6	0,153	4,4	6,3	11 000	0,062	▶ 305800 C-2Z	
35	12	15,9	9,04	4,555	0,193	3,8	5,4	9 500	0,078	▶ 305801 C-2Z	▶ 305701 C-2Z
40	15	15,9	10,1	5,5	0,263	5,85	8,5	9 000	0,1	▶ 305802 C-2Z	▶ 305702 C-2Z
47	17	17,5	13	7,35	0,315	9,3	13,4	8 000	0,16	▶ 305803 C-2Z	▶ 305703 C-2Z
52	20	20,6	16,5	9,5	0,4	8,3	12	7 000	0,22	▶ 305804 C-2Z	▶ 305704 C-2Z
62	25	20,6	18,6	11,8	0,5	15,3	21,6	6 000	0,32	▶ 305805 C-2Z	▶ 305705 C-2Z
72	30	23,8	25,1	16,3	0,695	17	24	5 000	0,49	▶ 305806 C-2Z	▶ 305706 C-2Z
80	35	27	31,9	20,4	0,865	15,6	22,4	4 300	0,65	▶ 305807 C-2Z	▶ 305707 C-2Z

▶ Popular item



Dimensions

d	d ₁ ≈	D ₁ ≈	r _{1,2} min.	a
mm				
32	15,8	25	0,6	16,5
35	17,7	27,7	0,6	19
40	20,2	30,7	0,6	21
47	23,3	35	0,6	23
52	27,7	40,9	1	28
62	32,7	45,9	1	30
72	38,7	55,2	1	36
80	45,4	63,9	1,1	42